

Overload Relays Class 10 Fixed Heater

Engineering Outline Drawings

RT1+RTXP	55-215830
RT2+RT2XP	55-215831
RT3 OLR.....	55-215832
RT4 OLR.....	55-215833
RT5 OLR.....	55-215834

Dimensional Drawings for RT4 and RT5 are shown on page 29.

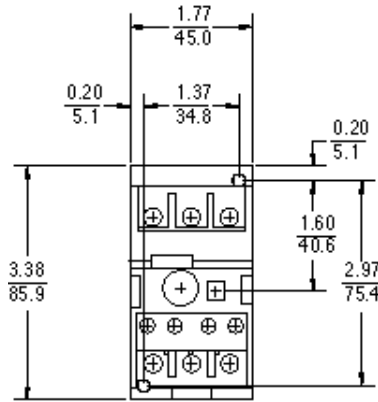

RT1 with RTXP Base Adapter - Front View

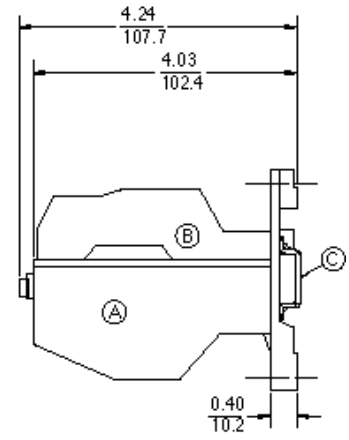

RT1 - Side View

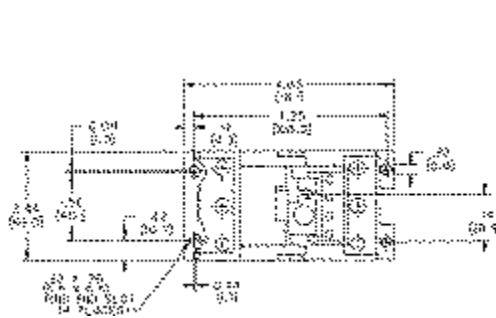

RT2 with RT2XP Base Adapter - Front View

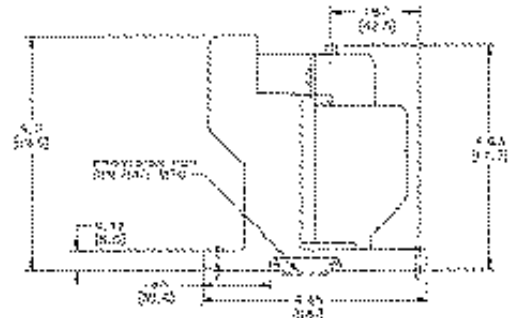

RT2 - Side View

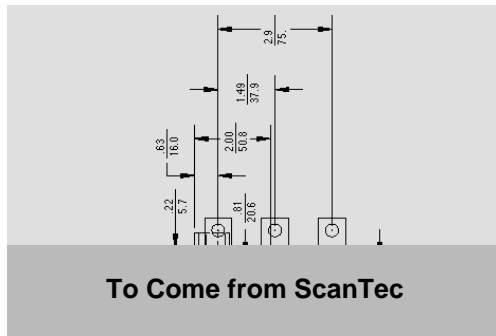

To Come from ScanTec

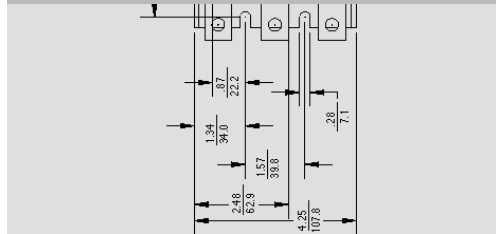

RT3 - Front View

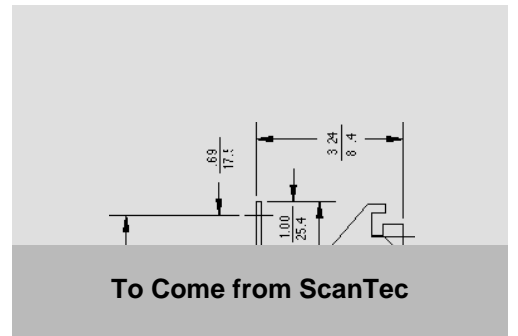

To Come from ScanTec

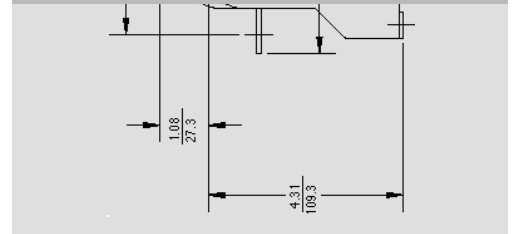

RT3 - Side View