









3RB20 solid-state overload relays with screw connection on auxiliary current side for direct mounting¹⁾²⁾ and stand-alone installation²⁾³⁾, CLASS 10 or CLASS 20

Features and technical specifications:

- Overload protection, phase failure protection and unbalance protection
- Internal power supply
- Auxiliary contacts 1 NO + 1 NC
- Manual and automatic RESET
- Switch position indicator
- TEST function and self-monitoring

	Size Contactor ⁴⁾	Set current value of the inverse-time delayed overload trip	Order No.	List Price \$	Weight per PU approx. kg
Size S00¹⁾					
	S00	0.1 ... 0.4	3RB20 16-1 RB0		0.200
		0.32 ... 1.25	3RB20 16-1 NB0		0.200
		1 ... 4	3RB20 16-1 PB0		0.200
		3 ... 12	3RB20 16-1 SB0		0.200
Size S0¹⁾					
	S0	0.1 ... 0.4	3RB20 26-1 RB0		0.220
		0.32 ... 1.25	3RB20 26-1 NB0		0.220
		1 ... 4	3RB20 26-1 PB0		0.220
		3 ... 12	3RB20 26-1 SB0		0.220
		6 ... 25	3RB20 26-1 QB0		0.220
Size S2¹⁾³⁾⁵⁾					
	S2	6 ... 25	3RB20 36-1 QB0		0.360
			3RB20 36-1 QW1		0.230
		12.5 ... 50	3RB20 36-1 UB0		0.360
			3RB20 36-1 UW1		0.230
Size S3¹⁾³⁾⁵⁾					
	S3	12.5 ... 50	3RB20 46-1 UB0		0.560
		25 ... 100	3RB20 46-1 EB0		0.560
		with busbar	3RB20 46-1 EW1		0.450
		with pass through CT's			
Size S6²⁾⁵⁾					
	S6	50 ... 200	3RB20 56-1 FC2		1.030
		with busbar	3RB20 56-1 FW2		0.690
		with pass through CT's			
Size S10/S12²⁾					
	S10/S12 and size 14 (3TF68/3TF69)	55 ... 250	3RB20 66-1 GC2		1.820
		160 ... 630	3RB20 66-1 MC2		1.820

2 Class 20

1 Class 10

- 1) The relays with an Order No. ending with "0" are designed for direct mounting to the contactor. With the matching terminal brackets (see Accessories) the sizes S00 and S0 can also be installed as stand-alone units.
- 2) The relays with an Order No. ending with "2" are designed for direct mounting and stand-alone installation. For 3TF68/3TF69 contactors, direct mounting is not possible.
- 3) The relays with an Order No. ending with "1" are designed for stand-alone installation.
- 4) Observe maximum rated operational current of the devices.
- 5) The relays with an Order No. with "W" in 11th position are equipped with a straight-through transformer.

For accessories, see pages 3/53-3/54.
For description, see pages 3/19-3/21.
For technical data, see pages 3/27-3/32.
For dimension drawings, see page 3/33.
For schematic diagrams, see page 3/34.



Dimensional drawings

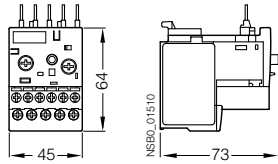

3RB20 16, 3RB21 13, size S00

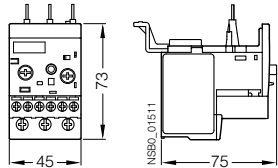

3RB20 26, 3RB21 23, size S0

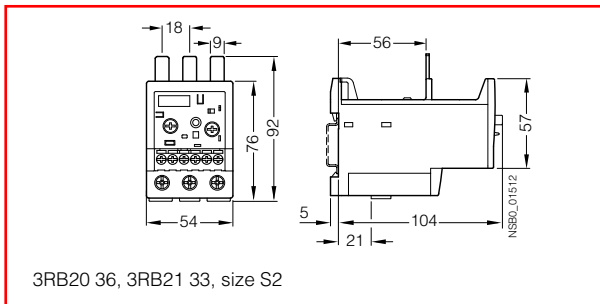

3RB20 36, 3RB21 33, size S2

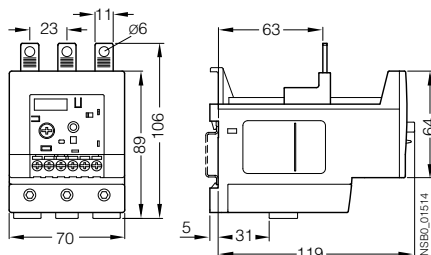

3RB20 46, 3RB21 43, size S3

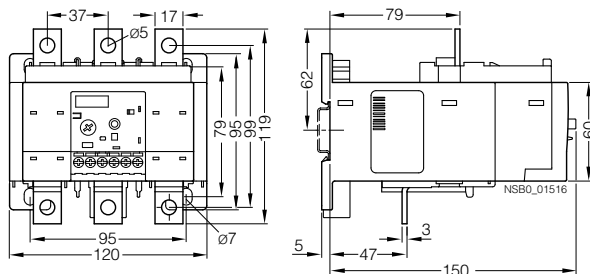

3RB20 56, 3RB21 53, size S6

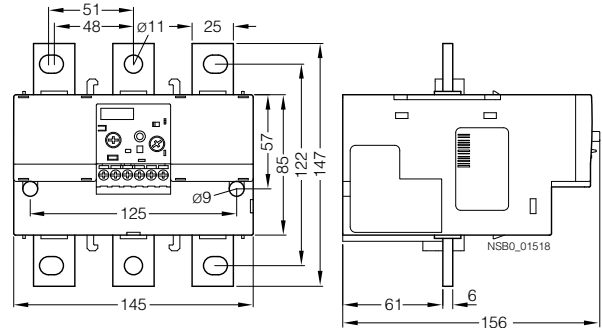

3RB20 66, 3RB21 63, size S10/S12

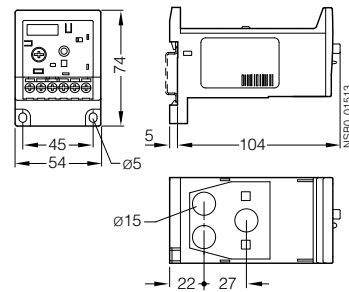

3RB20 36, 3RB21 33, size S2 with straight-through transformer

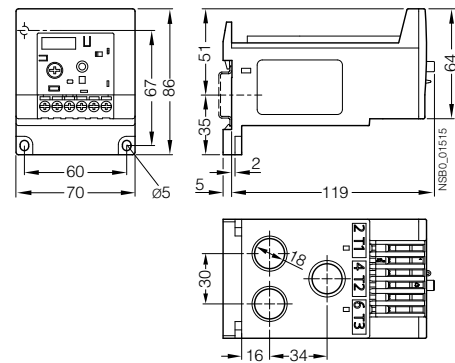

3RB20 46, 3RB21 43, size S3 with straight-through transformer

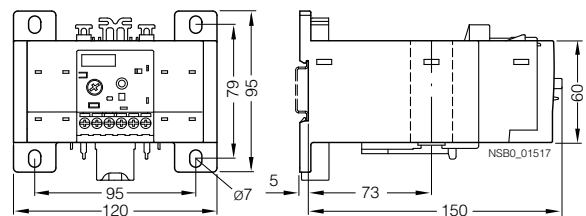

3RB20 56, 3RB21 53, size S6 with straight-through transformer